

Schnitt Deckel S3-S4 M1:5

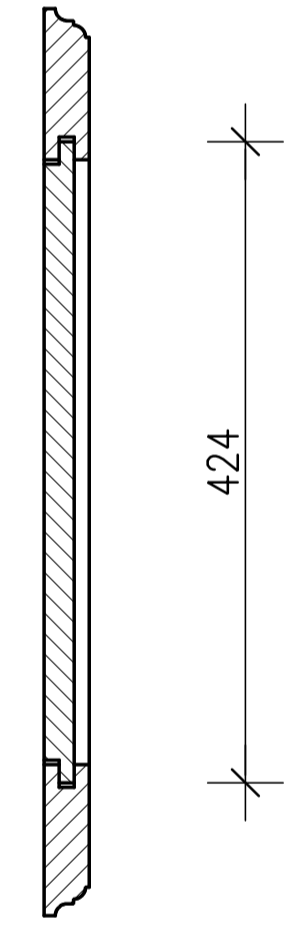

Schnitt Deckel A1-A2 M1:5

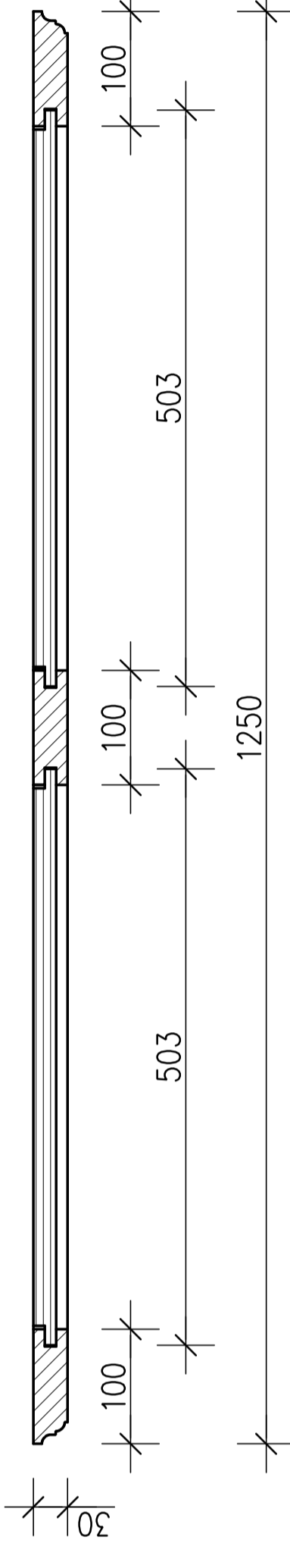

Fräser: FELDER 04.0.057  
 Profilmesser: FELDER P 04.4.073  
 FELDER A 04.A.073

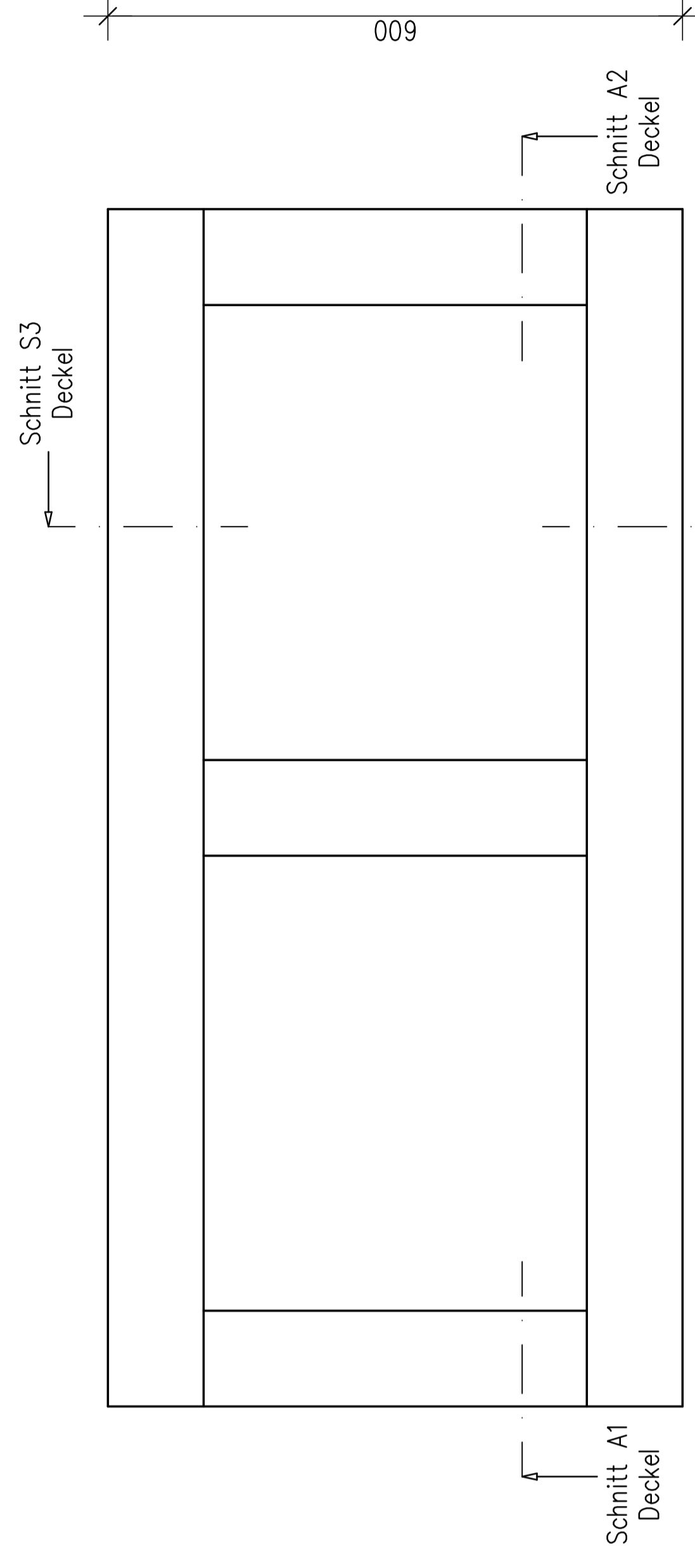

Detail Ansicht M1:1

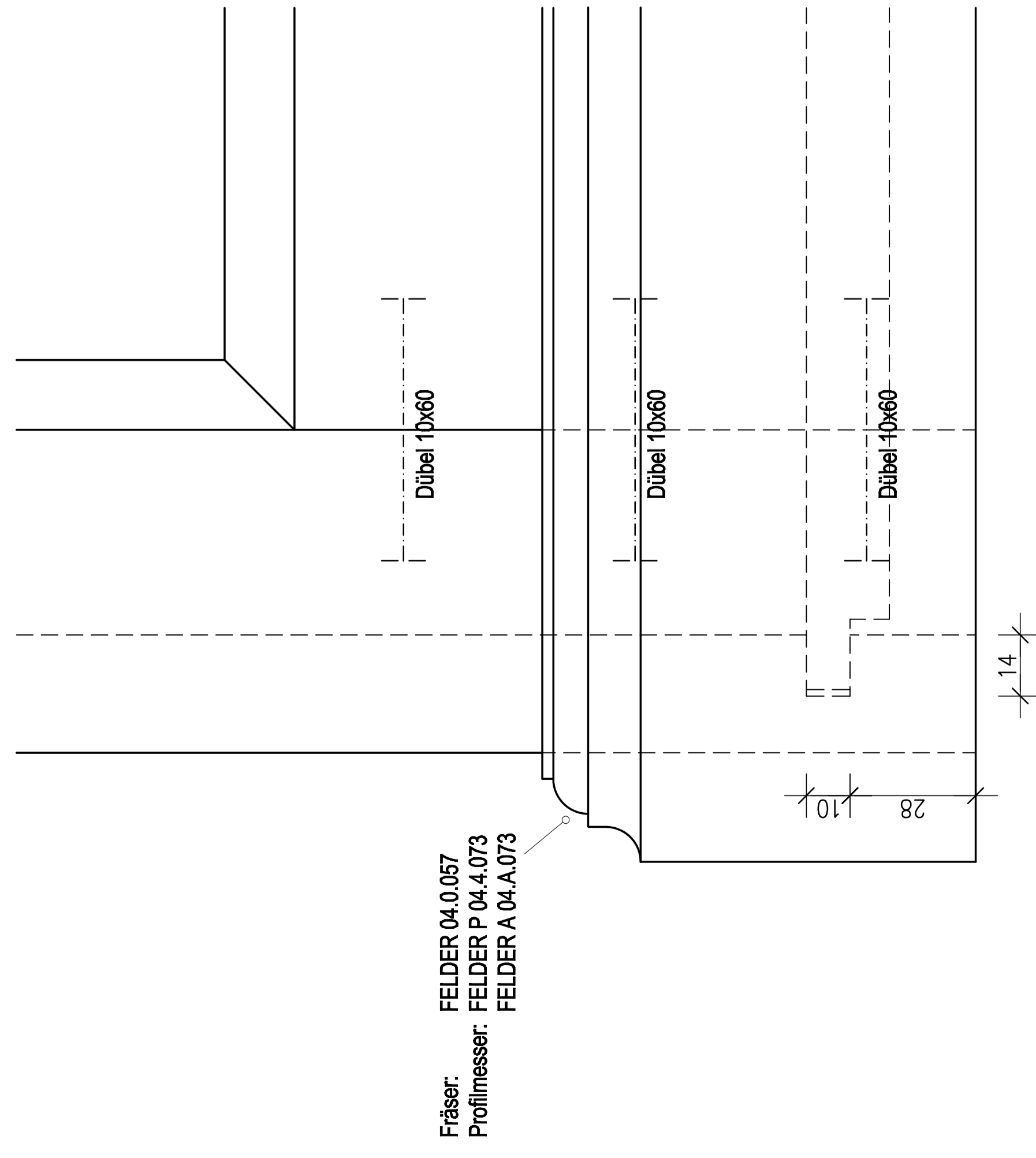

Fräser: FELDER 04.0.057  
 Profilmesser: FELDER P 04.4.073  
 FELDER A 04.A.073

Schnitt S1-S2 M1:5

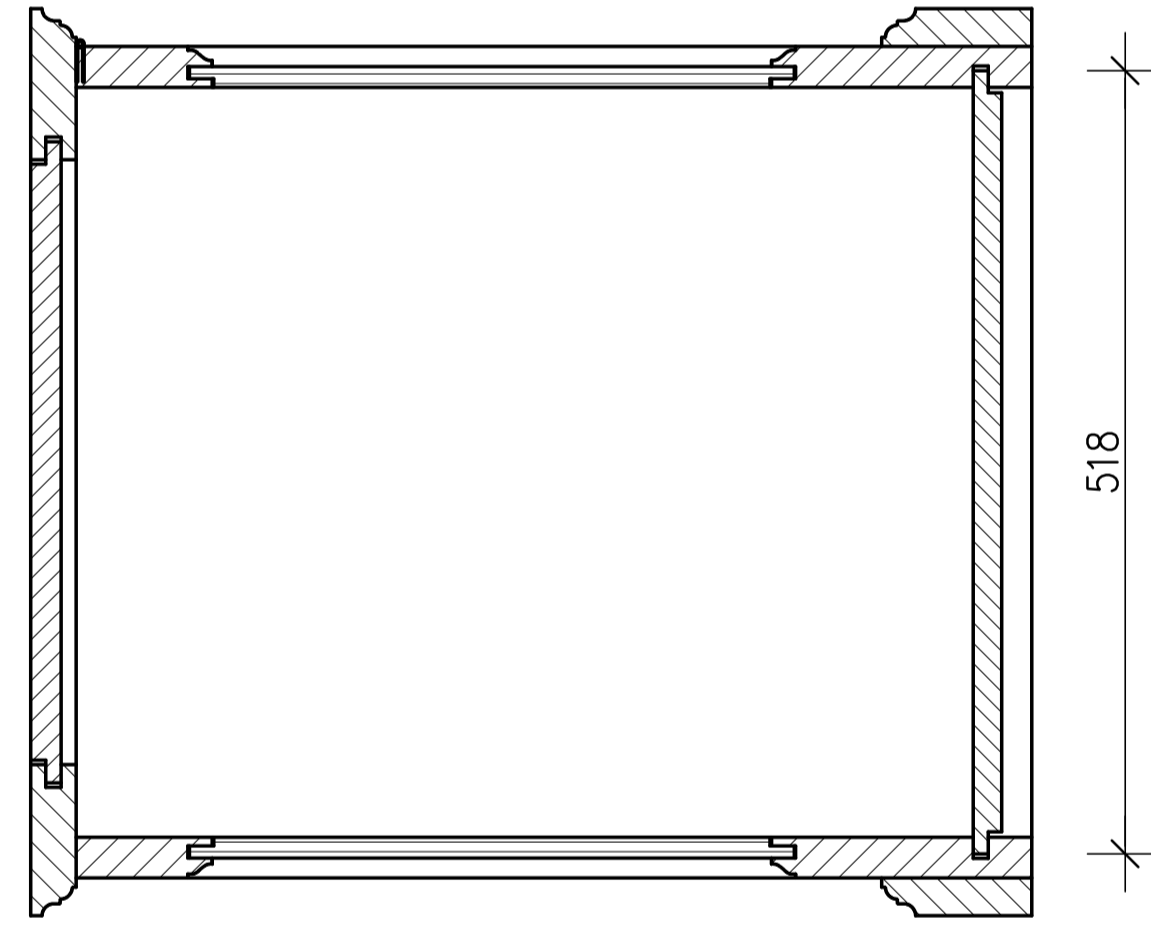

Schnitt S1

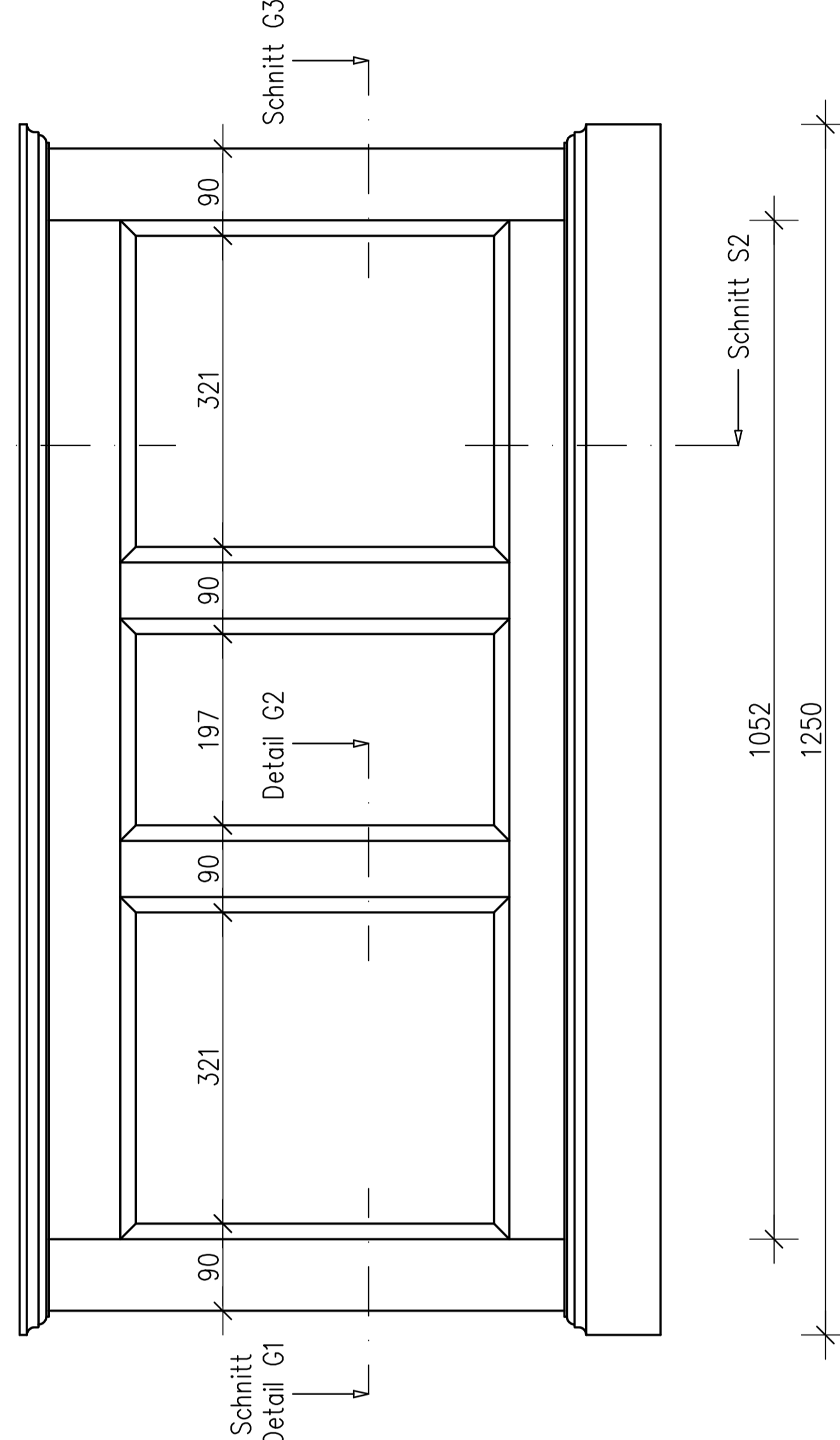

Schnitt G1-G3 M1:5

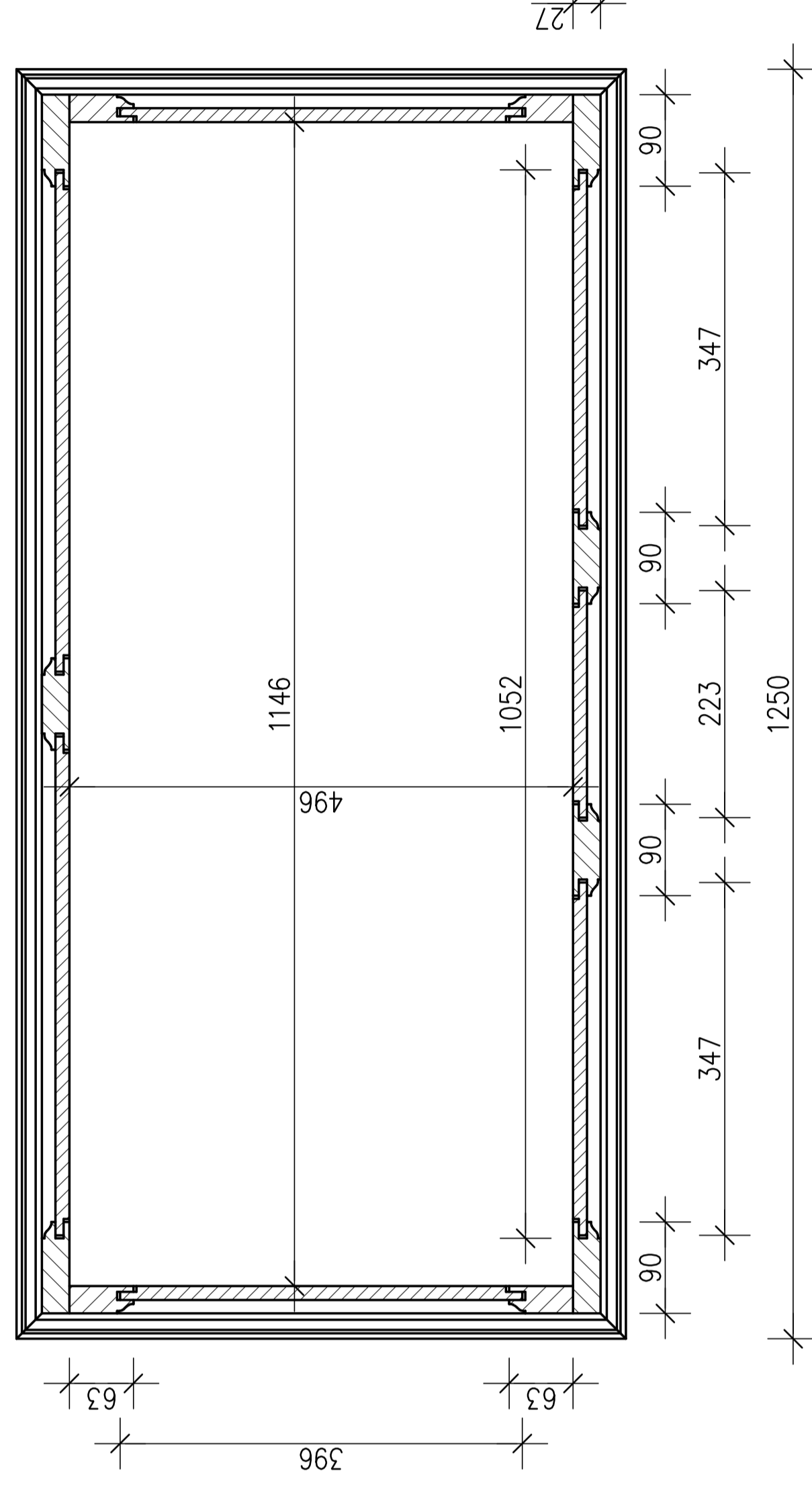

Detail/Schnitt G1-G2 M1:1

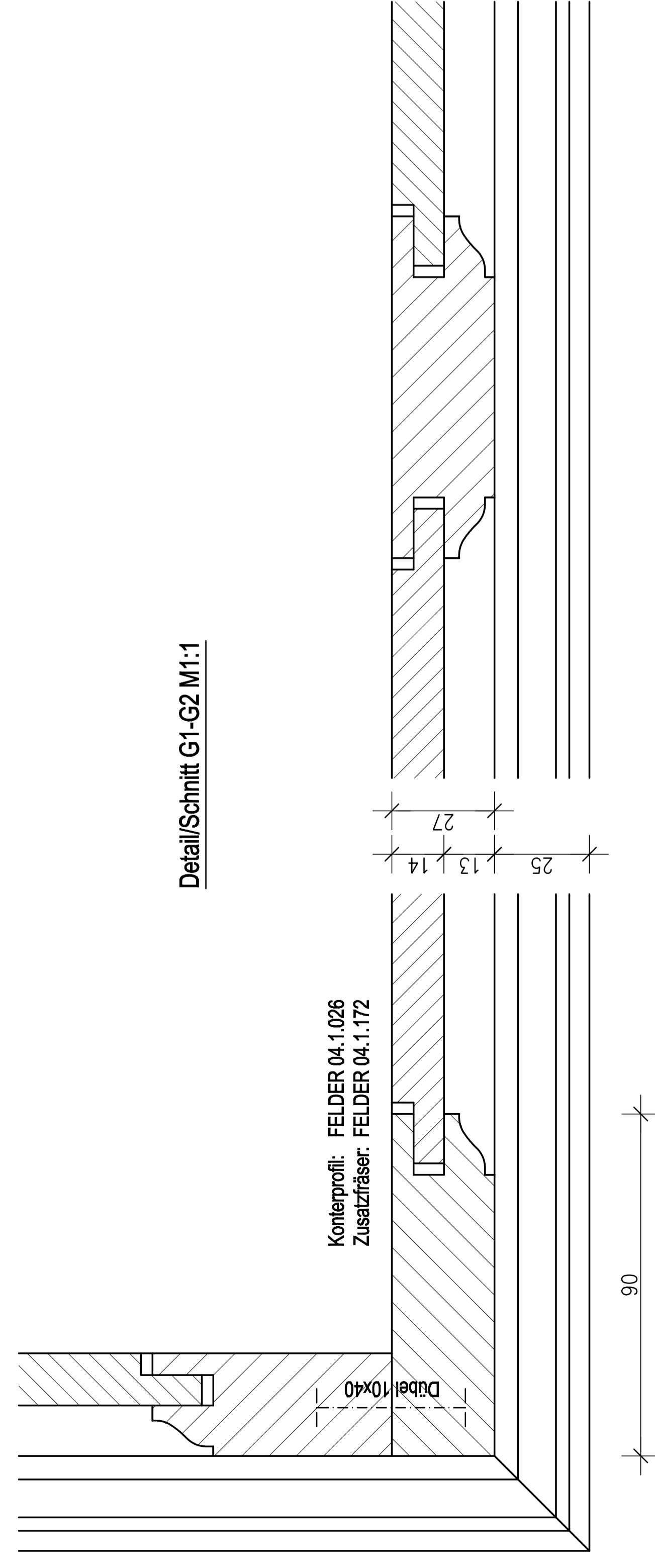

Kontierprofil: FELDER 04.1.026  
 Zusatzfräser: FELDER 04.1.172

<b>Ausführung</b>	Fichte Altholz gebürstet
<b>Material:</b>	Gewachst, Poliert
<b>Fräswerkzeuge:</b>	
Kontierprofil:	FELDER 04.1.026
Zusatzfräser:	FELDER 04.1.172
Profilmesser:	FELDER P 04.4.073
Hochleistungsabkopf:	FELDER A 04.A.073
Profil Nutfräser:	FELDER 04.1.058
	FELDER 04.1.173

<b>Materialliste (Feigmass)</b>	
Füllung Deckel	2 Stk. 503 x 424 x 14 mm
Füllung Truhe	2 Stk. 400 x 491 x 14 mm
	2 Stk. 400 x 396 x 14 mm
	2 Stk. 400 x 347 x 14 mm
	1 Stk. 400 x 223 x 14 mm
Boden	1 Stk. 1171 x 518 x 22 mm
Frise Deckel	2 Stk. 1250 x 100 x 30 mm
	3 Stk. 490 x 100 x 30 mm
Frise Truhe	2 Stk. 1052 x 172 x 27 mm
	2 Stk. 1052 x 90 x 27 mm
	4 Stk. 632 x 90 x 27 mm
	4 Stk. 632 x 63 x 27 mm
	3 Stk. 402 x 90 x 27 mm
	2 Stk. 402 x 172 x 27 mm
Sockel	2 Stk. 1250 x 100 x 25 mm
	2 Stk. 600 x 100 x 25 mm